

Bidirectional Transil™ array for data line protection

Features

- High surge capability Transil array:
 $I_{PP} = 40 \text{ A (8/20 } \mu\text{s)}$
- Peak pulse power: 300 W (8/20 μs)
- Up to 5 bidirectional Transil functions
- Low clamping factor (V_{CL} / V_{BR}) at high current level
- Low leakage current
- ESD protection up to 15 kV

Complies with the following standards

- IEC 61000-4-2 level 4
 - 15 kV (air discharge)
 - 8 kV (contact discharge)
- MIL STD 883G- Method 3015-7: class 3B
 - 25 kV (human body model)

Applications

Differential data transmission line protection, such as:

- RS-232
- RS-423
- RS-422
- RS-485

Description

Transil diode arrays provide high overvoltage protection by clamping action. Their instantaneous response to transient overvoltages makes them particularly suited to protect voltage sensitive devices such as MOS technology and low voltage supplied IC's.

The ITA series combines high surge capability against energetic pulses with high voltage performance against ESD.

TM: Transil is a trademark of STMicroelectronics

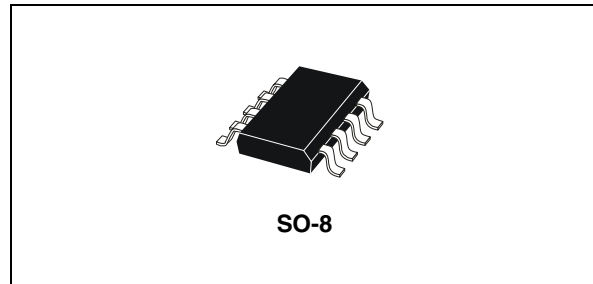
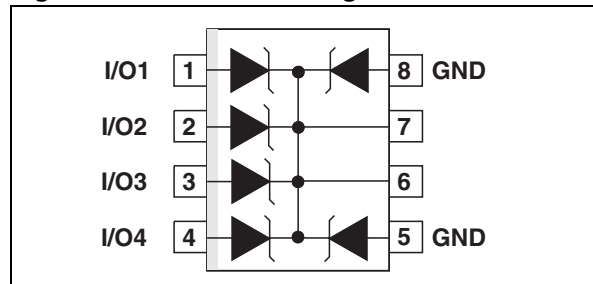

Figure 1. Functional diagram



1 Characteristics

Table 1. Absolute ratings ($T_{amb} = 25\text{ }^{\circ}\text{C}$)

Symbol	Parameter		Value	Unit
P_{PP}	Peak pulse power (8/20 μs) ⁽¹⁾	T_j initial = T_{amb}	300	W
I_{PP}	Peak pulse current (8/20 μs) ⁽¹⁾	T_j initial = T_{amb}	40	A
I^2t	Wire I^2t value ⁽¹⁾		0.6	A^2s
T_j	Maximum operating junction temperature		125	$^{\circ}\text{C}$
T_{stg}	Storage temperature range		-55 to +150	$^{\circ}\text{C}$
T_L	Maximum lead temperature for soldering during 10 s at 5 mm for case		260	$^{\circ}\text{C}$

1. For surges greater than the specified maximum value, the I/O will first present a short-circuit and after an open circuit caused by the wire melting.

Table 2. Electrical characteristics ($T_{amb} = 25\text{ }^{\circ}\text{C}$)

Symbol	Parameter									
V_{RM}	Stand-off voltage									
V_{BR}	Breakdown voltage									
V_{CL}	Clamping voltage									
I_{RM}	Leakage current									
I_{PP}	Peak pulse current									
αT	Voltage temperature coefficient									
C	Capacitance									
Order code	V_{BR} @ I_R		I_{RM} @ V_{RM}		V_{CL} @ I_{PP}		V_{CL} @ I_{PP}		αT	C
	min.		max.		8/20 μs		max. 8/20 μs		max.	max.
	(1)				(1)		(1)			(2)
	V	mA	μA	V	V	A	V	A	$10^{-4}/^{\circ}\text{C}$	pF
ITA6V5B1	6.5	1	10	5	10	10	12	25	4	750
ITA10B1	10	1	4	8	15	10	19	25	8	570
ITA18B1	18	1	4	15	25	10	28	25	9	350
ITA25B1	25	1	4	24	33	10	38	25	12	300

1. Between I/O pin and ground.
2. Between two input pins at 0 V Bias, F = 1 MHz.

Figure 2. Pulse waveform

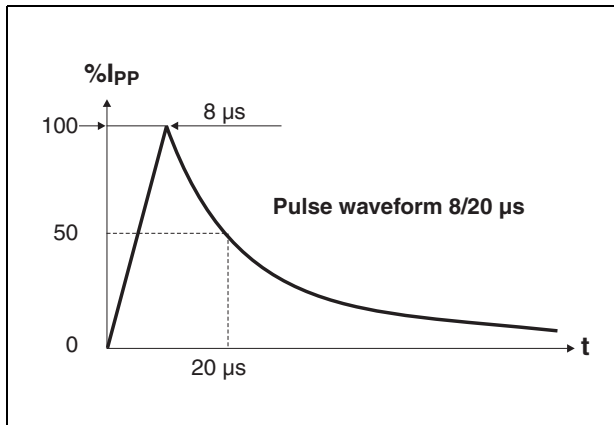

Figure 3. Typical peak pulse power versus exponential pulse duration

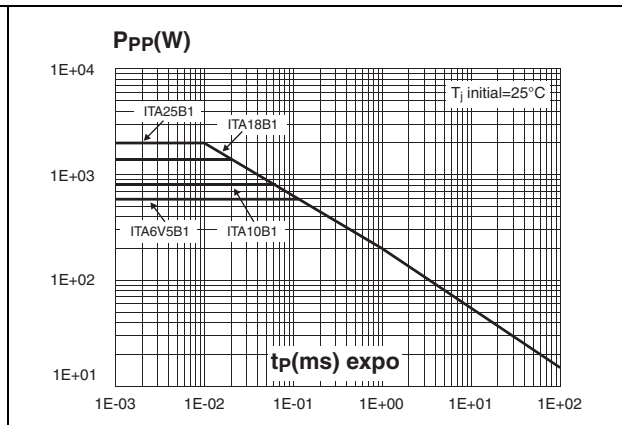

Figure 4. Clamping voltage versus peak pulse current (exponential waveform 8/20 μs)

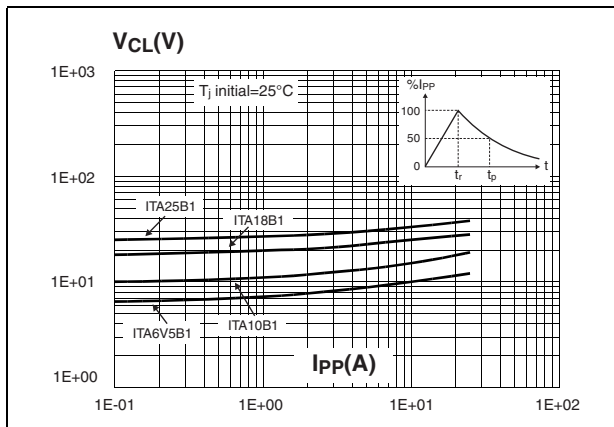

Figure 5. Peak current Idc inducing open circuit of the wire for one input/output versus pulse duration (typical values)

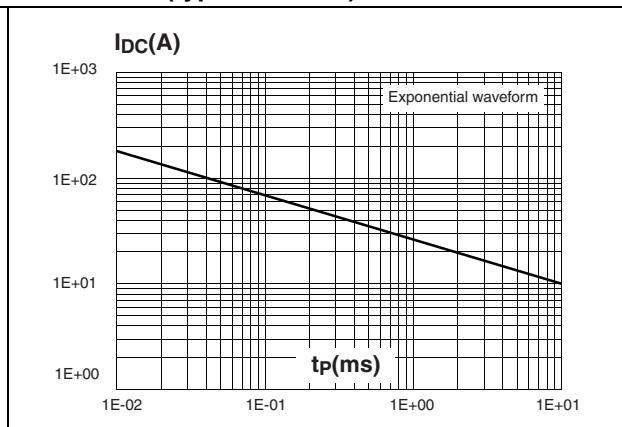

Figure 6. Junction capacitance versus reverse applied voltage for one input/output (typical values)

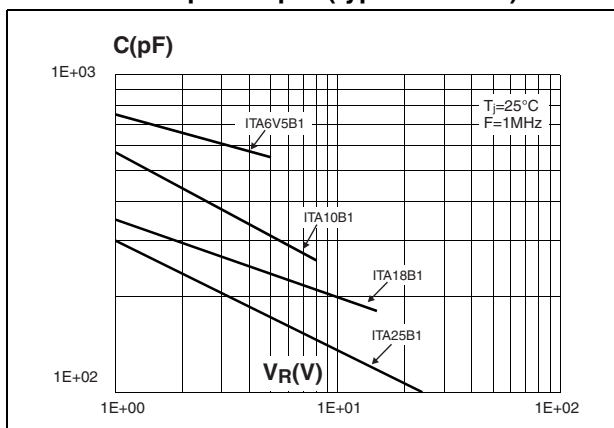
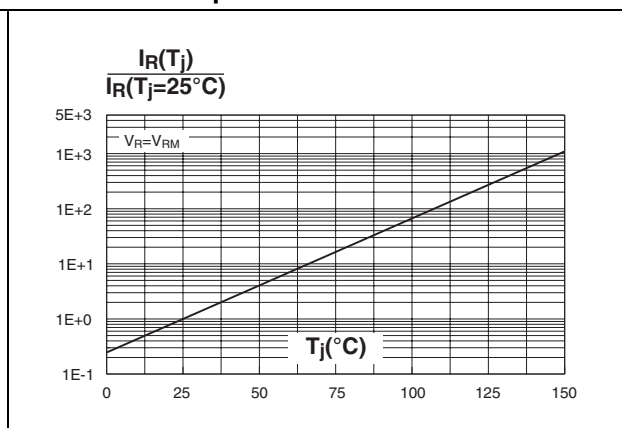

Figure 7. Relative variation of leakage current versus junction temperature



2 Application information

This monolithic Transil Array is based on 6 unidirectional Transils with a common cathode and can be configured to offer up to 5 bidirectional functions. This imposes a maximum differential voltage between 2 input pins (see [Table 3](#)).

Table 3. Maximum differential voltages

Order code	Maximum differential voltage between two input pins at 25 °C
ITA6V5B1	± 3.5 V
ITA10B1	± 5.0 V
ITA18B1	± 9.0 V
ITA25B1	± 12.5 V

Figure 8. RS-232 junction (typical application)

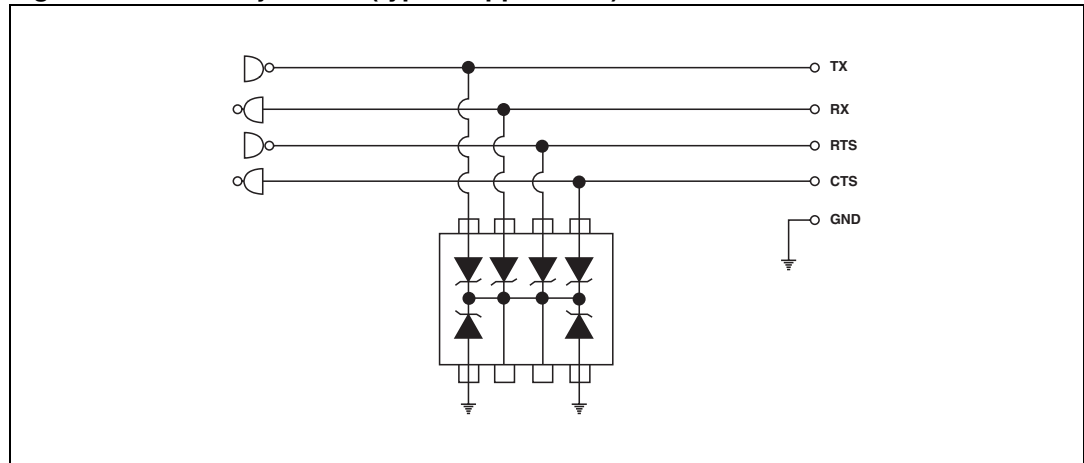

3 Ordering information scheme

Figure 9. Ordering information scheme

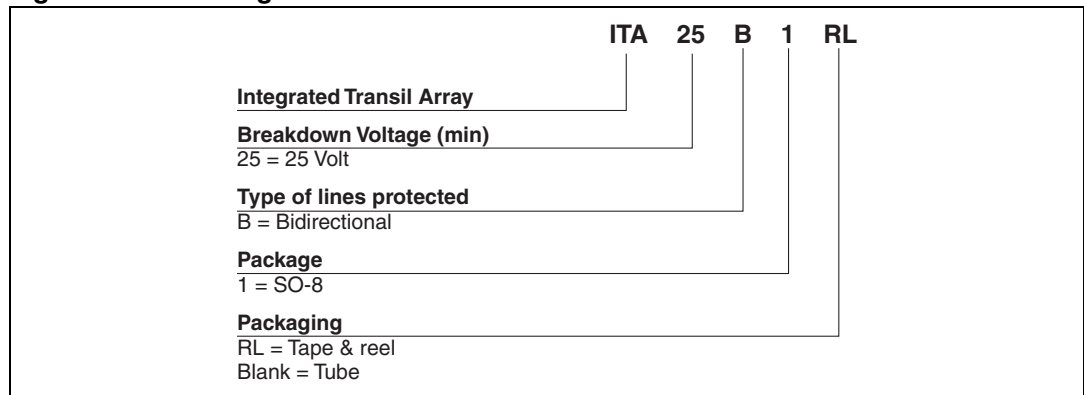

4 Package information

- Epoxy meets UL94, V0

In order to meet environmental requirements, ST offers these devices in ECOPACK® packages. These packages have a lead-free second level interconnect. The category of second level interconnect is marked on the package and on the inner box label, in compliance with JEDEC Standard JESD97. The maximum ratings related to soldering conditions are also marked on the inner box label. ECOPACK is an ST trademark. ECOPACK specifications are available at: www.st.com.

Table 4. SO-8 dimensions

Ref.	Dimensions					
	Millimeters			Inches		
	Min.	Typ.	Max.	Min.	Typ.	Max.
A			1.75			0.069
A1	0.1		0.25	0.004		0.010
A2	1.25			0.049		
b	0.28		0.48	0.011		0.019
C	0.17		0.23	0.007		0.009
D	4.80	4.90	5.00	0.189	0.193	0.197
E	5.80	6.00	6.20	0.228	0.236	0.244
E1	3.80	3.90	4.00	0.150	0.154	0.157
e		1.27			0.050	
h	0.25		0.50	0.010		0.020
L	0.40		1.27	0.016		0.050
L1		1.04			0.041	
k°	0		8	0		8
ccc			0.10			0.004

Figure 10. SO-8 footprint (dimensions in mm)

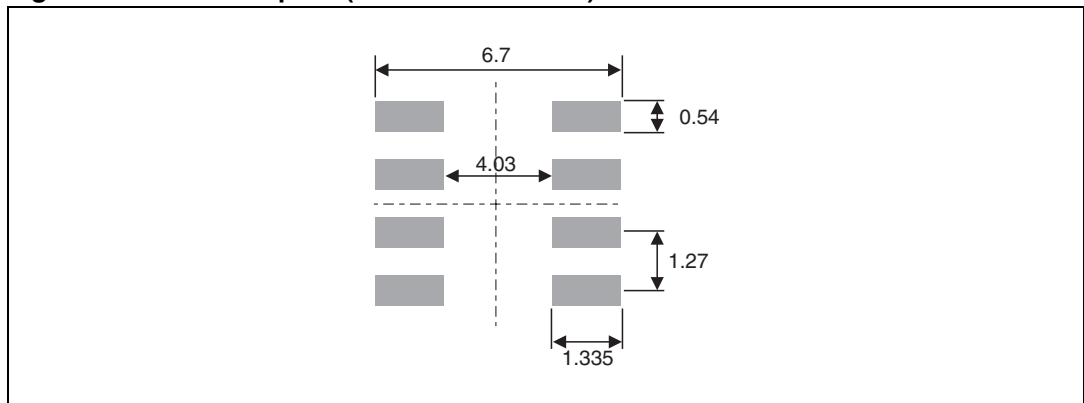

5 Ordering Information

Table 5. Ordering information

Order code	Marking	Package	Weight	Base qty	Delivery mode
ITA6V5B1	6V5B1	SO-8	0.08 g	2000	Ammopack
ITA6V5B1RL	6V5B1			2500	Tape and reel
ITA10B1	10B1			2000	Ammopack
ITA18B1	18B1			2000	Ammopack
ITA18B1RL	18B1			2500	Tape and reel
ITA25B1	25B1			2000	Ammopack
ITA25B1RL	25B1			2500	Tape and reel

6 Revision history

Table 6. Document revision history

Date	Revision	Description of changes
13-Dec-2004	1	First issue.
15-Nov-2007	2	Reformatted to current standards. SO-8 package dimensions update. Updated pulse waveform parameters in Figure 2 .

Please Read Carefully:

Information in this document is provided solely in connection with ST products. STMicroelectronics NV and its subsidiaries ("ST") reserve the right to make changes, corrections, modifications or improvements, to this document, and the products and services described herein at any time, without notice.

All ST products are sold pursuant to ST's terms and conditions of sale.

Purchasers are solely responsible for the choice, selection and use of the ST products and services described herein, and ST assumes no liability whatsoever relating to the choice, selection or use of the ST products and services described herein.

No license, express or implied, by estoppel or otherwise, to any intellectual property rights is granted under this document. If any part of this document refers to any third party products or services it shall not be deemed a license grant by ST for the use of such third party products or services, or any intellectual property contained therein or considered as a warranty covering the use in any manner whatsoever of such third party products or services or any intellectual property contained therein.

UNLESS OTHERWISE SET FORTH IN ST'S TERMS AND CONDITIONS OF SALE ST DISCLAIMS ANY EXPRESS OR IMPLIED WARRANTY WITH RESPECT TO THE USE AND/OR SALE OF ST PRODUCTS INCLUDING WITHOUT LIMITATION IMPLIED WARRANTIES OF MERCHANTABILITY, FITNESS FOR A PARTICULAR PURPOSE (AND THEIR EQUIVALENTS UNDER THE LAWS OF ANY JURISDICTION), OR INFRINGEMENT OF ANY PATENT, COPYRIGHT OR OTHER INTELLECTUAL PROPERTY RIGHT.

UNLESS EXPRESSLY APPROVED IN WRITING BY AN AUTHORIZED ST REPRESENTATIVE, ST PRODUCTS ARE NOT RECOMMENDED, AUTHORIZED OR WARRANTED FOR USE IN MILITARY, AIR CRAFT, SPACE, LIFE SAVING, OR LIFE SUSTAINING APPLICATIONS, NOR IN PRODUCTS OR SYSTEMS WHERE FAILURE OR MALFUNCTION MAY RESULT IN PERSONAL INJURY, DEATH, OR SEVERE PROPERTY OR ENVIRONMENTAL DAMAGE. ST PRODUCTS WHICH ARE NOT SPECIFIED AS "AUTOMOTIVE GRADE" MAY ONLY BE USED IN AUTOMOTIVE APPLICATIONS AT USER'S OWN RISK.

Resale of ST products with provisions different from the statements and/or technical features set forth in this document shall immediately void any warranty granted by ST for the ST product or service described herein and shall not create or extend in any manner whatsoever, any liability of ST.

ST and the ST logo are trademarks or registered trademarks of ST in various countries.

Information in this document supersedes and replaces all information previously supplied.

The ST logo is a registered trademark of STMicroelectronics. All other names are the property of their respective owners.

© 2007 STMicroelectronics - All rights reserved

STMicroelectronics group of companies

Australia - Belgium - Brazil - Canada - China - Czech Republic - Finland - France - Germany - Hong Kong - India - Israel - Italy - Japan - Malaysia - Malta - Morocco - Singapore - Spain - Sweden - Switzerland - United Kingdom - United States of America

www.st.com